

f o r a b e t t e r s m i l e

Ressorts Nickel-Titane[®]



Nickel-Titanium(NT) Coil Spring

Wire diameter

- Light 0.21mm(0.009")
- Medium & Heavy 0.23mm(0.010")

Spring diameter

- 0.9mm(0.036")

Strength

- Light(L), Medium(M), Heavy(H)

Length

- 8mm & 13mm

Hole diameter

- Ø1.5, Ø2.0, Ø2.5

Coil Spring Holder (CSH)









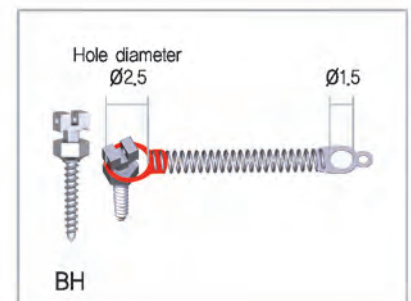
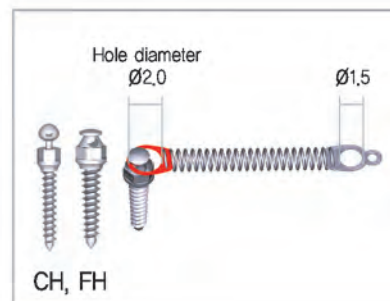
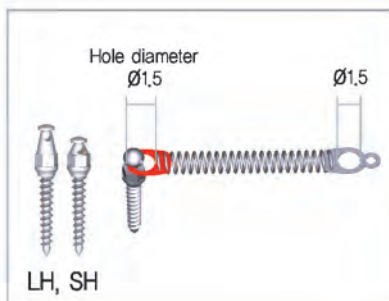













Coil Spring Case (CSC)



◀ Each case is detachable



NT Coil spring

Length	Hole Diameter (Φ)	Strength		
		Light (009x036)	Medium (010x036)	Heavy(010x036)
8mm 	Φ1.5	 NT15-8L	 NT15-8M	 NT15-8H
	Φ2.0	 NT20-8L	 NT20-8M	 NT20-8H
	Φ2.5	 NT25-8L	 NT25-8M	 NT25-8H
13mm 	Φ1.5	 NT15-13L	 NT15-13M	 NT15-13H
	Φ2.0	 NT20-13L	 NT20-13M	 NT20-13H
	Φ2.5	 NT25-13L	 NT25-13M	 NT25-13H

NT Coil spring – Weight Range

Weight Range (8mm length)

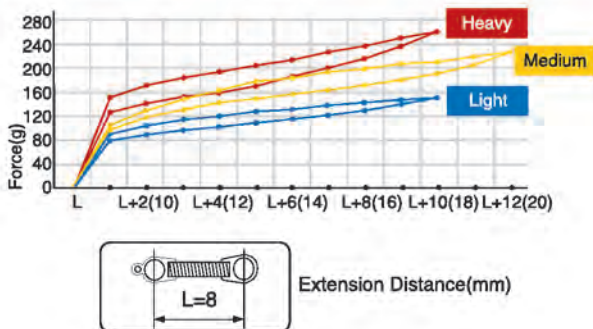

Weight Range (13mm length)

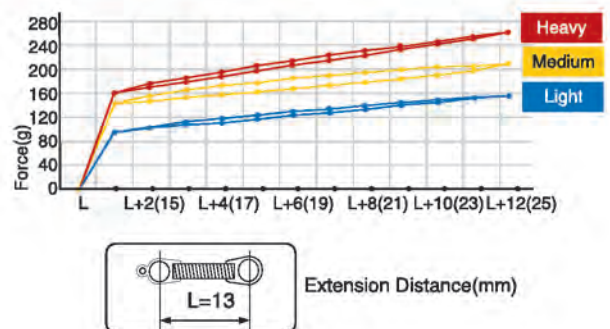



for a better smile!

Distribué par



13 rue du Colonel Raynal F-93100 MONTREUIL

Tel. +33 1 43 60 77 08 - Fax. +33 1 43 60 79 05

www.dentalforce.fr / info@dentalforce.fr

Fabriqué par

Dentos
Dentos Inc.

Office

Dong Bu B/D 2F #22, 251, 4 Ga,
Dongin-Dong, Jung-Gu, Daegu,
KOREA 700-424

Tel) +82-(0)53-424-5947

Fax) +82-(0)53-421-7607

Research Lab

Prof. Hee-Moon Kyung
Dept. of Orthodontics, Dental School,
Kyungpook National University, 188-1, 2Ga,
Samduk-Dong, Jung-Gu, Daegu, KOREA 700-412

hmkjung@knu.ac.kr

Tel) +82-(0)53-420-5947

Fax) +82-(0)53-421-7607

Factory

#106, Daegu
Venture Technopark, 711,
Hosan-Dong, Dalseo-Gu,
Daegu, KOREA 704-230

Tel) +82-(0)53-592-5908

Fax) +82-(0)53-592-5909